

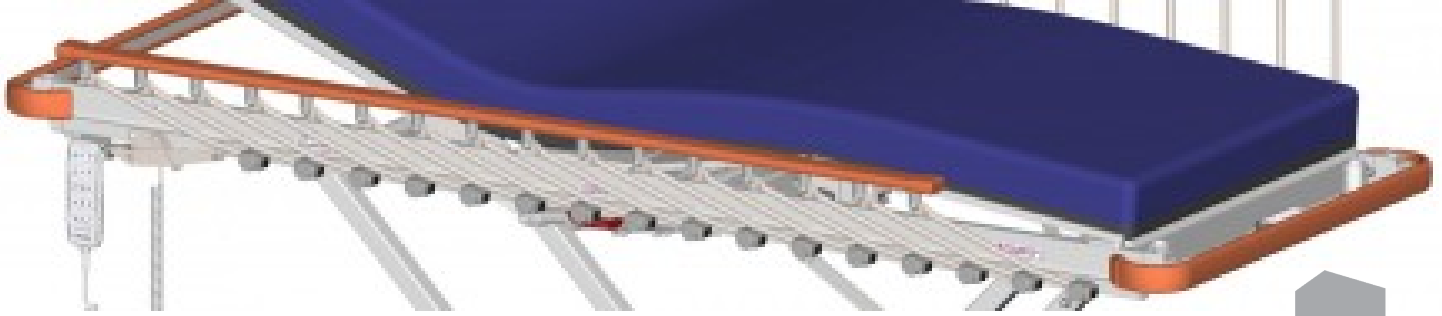

## Contour Jazz User Guide

**MODSEL**

[modsel.com](https://www.modsel.com) ▶



# Contour Jazz User Guide

Thank you for placing your confidence in our Stretchers. They have been engineered from quality materials and hand-made with care to fulfil the requirements of the healthcare industry. Your stretcher will give years of trouble-free service if used and cared for in accordance with our directions.

This stretcher is a re-usable, mobile device for transient to short-term use in a healthcare environment that allows a patient to be adequately supported during transport/transfer for the purpose of care, nursing, examination and/or treatment within the environment. A range of models, designs, features and accessories are available for this customisable device.

These instructions for use are for powered (electric battery) stretchers. This stretcher contains metal hydraulic and electrically powered (low voltage) components. Associated electrical interference potential and/or magnetic safety issues may merit special consideration in your healthcare environment.

Before using your [Contour Jazz Stretcher](#) please take the time to read our user guide carefully and familiarise yourself with the controls and safe operation of the unit.

**IT IS IMPORTANT TO ASSESS THAT THIS EQUIPMENT IS SUITABLE FOR YOUR CLINICAL NEEDS.**

# Product Overview

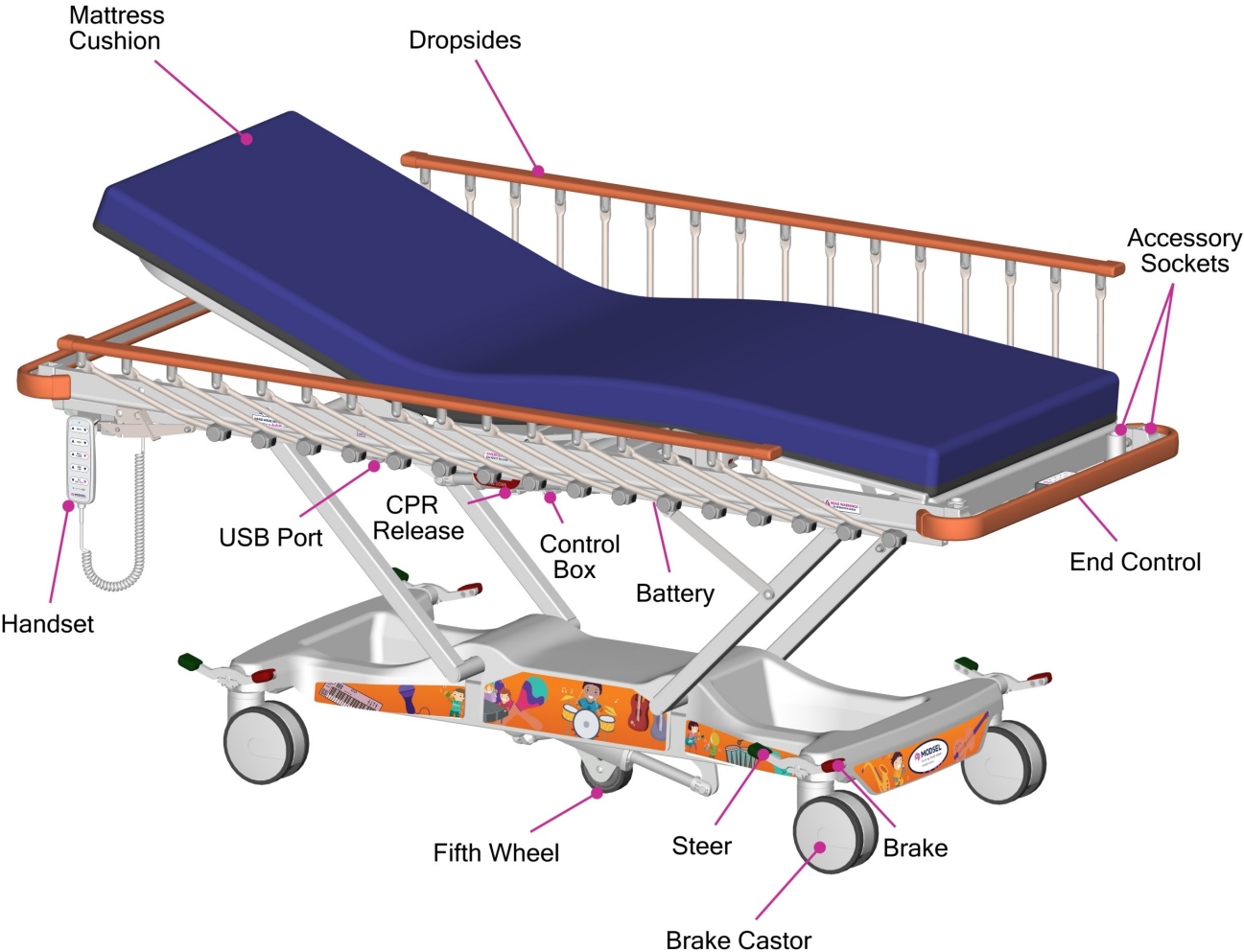

**Overall Size:** 2135 x 815mm overall size (965mm wide top option)

**Height Range:** 400 - 830mm

**SWL:** 300kg

# Product Warnings

## Patient/Staff Safety

- Patients, especially children must not be left unattended on or with a stretcher at any time.
- Care must be taken in the operation of all moving parts and accessories to minimise risk of injury to staff or patients.
- This stretcher is not suitable for use as a ward bed. Use for more than a few hours could contribute to patient discomfort and increase the potential for injury, including development of pressure injury.
- The stretcher top must be in the lowest position when patients are getting on or off the stretcher, with access from either side only.
- Maximum static patient load capacity on the backrest must not exceed 100kg distributed evenly or damage to locking struts and frame may occur.
- Maximum static patient load capacity on the stretcher is 300kg and must not be exceeded. Weight must be distributed as evenly as possible on stretcher top. Any weight loading above 150kg must be wheeled on smooth, level flooring and attended by more than one staff member.
- Only apply brakes when stretcher is stationary.
- Brakes are to be fully applied during bed / stretcher transfers and attended by qualified clinical staff.

## General Use

- The backrest must be raised and lowered with care to prevent possible strain to the operator.
- Check that all fingers, hands and limbs are clear before lowering backrest.
- Check that there are no obstructions above or below the top before adjusting the height.
- The stretcher must never be left on sloping surfaces unattended, even with brakes fully engaged.
- Traversing side on, across slopes is to be avoided under any circumstances.
- On wet or slippery flooring do not lean or apply unnecessary force against stretcher, as it may slide: even with brakes fully applied.
- This stretcher is specifically designed for indoor use in dry environments, with due care it may be used to transit outdoor areas however additional controls and precautions specific to the environment will be merited.
- Clips, locks and retainers are supplied by the manufacturer for patient / staff safety and must not be removed.

## Dropsides

- Stretcher must never be raised or moved with dropsides down.
- Patients on a stretcher with dropsides down, must always be attended by qualified clinical staff.
- Dropside releases must be operated only by suitably qualified clinical staff in attendance.
- Check that all fingers, hands and limbs are clear before lowering dropsides.
- Always ensure dropsides are locked firmly in position after raising.
- Side loading on any dropsides should not exceed 80kg or damage to the stretcher may occur.
- Dropsides locked in mid position should not be subjected to any downward force exceeding 30kg static loading as this may result in damage to the stretcher or personal injury.

## **Mattress**

- This stretcher is specifically designed for use in conjunction with a Modsel Protran, Premia or Premia Forte mattress.
- This stretcher mattress provides only a low level of cushioning and insulation, elderly, frail and other individuals may be particularly susceptible to temperature and/or pressure related injury in some healthcare environments; take appropriate care.
- When covering the mattress with a sheet, always ensure that there is sufficient non-slip base material (more than 75% area of the mattress) contacting the stretcher top surface, to prevent slippage or movement of the mattress.
- This stretcher mattress may contain a metal zip; associated electrical and/or magnetic safety issues may merit special consideration in your healthcare environment.
- DO NOT PIN or STAPLE labels etc on cover, as this will breach the waterproof integrity of the fabric.
- If identification is required write on the cover using a LAUNDRY SAFE FELT TIPPED MARKER.

## **Electric Operation**

- All electric functions must be operated only by suitably qualified clinical staff in attendance.
- Stretcher top must not be lowered onto any object or irreparable damage will occur.
- Fingers, hands and limbs must be kept clear of all electrically operated parts.
- ONLY USE THE BACKREST CPR QUICK RELEASE IN AN EMERGENCY - continuous use will prematurely wear or damage the release mechanism.
- Ensure that the electric backrest is supported by a staff member each side before using the quick release.
- If the backrest quick release is activated, lower the backrest completely flat to reset.
- Only charge via a standard 240V power point. DO NOT MOVE the stretcher before disconnecting mains power.
- Do not recharge the battery in a wet area.

## **Maintenance**

- Periodic maintenance must be done in accordance with the operator and instruction manual to ensure the safest product at all times.
- If any faults are evident, the stretcher should be immediately removed from service until repaired.

# Safe Operation

## **YOUR OWN AND YOUR PATIENT SAFETY REQUIRES THAT YOU ALWAYS CHECK THE STRETCHER FUNCTION BEFORE USE.**

- Are the castor's free moving and firmly attached?
- Do the dropsides and other movable parts operate correctly?
- Are the visible surfaces free from damage, soiling and undue wear?
- Is the full unit clean and hygienic?
- Is the handset controller and wiring free from damage?
- Is the stretcher design suitable for the patient and the anticipated healthcare environment?
- Is the stretcher included in your institution's preventative maintenance plan?
- Does the stretcher operate correctly, without undue vibration, noise and/or physical stresses? IF NOT, DO NOT USE.
- Isolate and quarantine the stretcher with the suspected malfunction. Contact Modsel or an authorised agent for advice.

## **PATIENT SAFETY REQUIRES THAT YOU ALWAYS CHECK THE MATTRESS BEFORE USE.**

- A Modsel Protran, Premia or Premia Forte mattress is specifically designed for use in conjunction with Modsel Contour stretcher models.
- The edges should align well with the sides of the stretcher, with no more than a 1cm gap between the edges in any direction.
- The mattress will have seams or flex capability that closely aligns with the movement capability of the stretcher top.
- Is the mattress clean and suitable for use?
- Is the mattress free from any visible damage including to fabric and seams?
- If there is a zipper, is it fully closed?
- Is the mattress correctly placed? The non-slip side of the mattress must be in direct contact with the top of the stretcher.
- Are the head and foot ends correctly orientated?
- When fitting a sheet, ensure that at least 75% of the non-slip surface of the mattress directly contacts the stretcher top.

# Steer / Brake System



## To steer the stretcher

- Press one of the corner GREEN pedals on the base down fully to activate steering.
- Press the opposite RED pedal back to the horizontal (neutral) position to disengage steering.
- There are variety of ways stretcher steering is controlled while moving. These may include the option of a corner castor locked into a straight position or as standard a 5th (center) steer wheel pressured onto the floor.
- It is recommended that a stretcher with corner steering is always pushed from the opposite end to which the steer castor is positioned, however the end from which a stretcher is pushed from is subject to an organisations internal policy and risk assessment.
- To move the stretcher sideways, always ensure the pedals are in the horizontal (neutral) position.

## To brake when parked

- Press one of the corner RED pedals down fully to activate all four castor brakes.
- Press the opposite GREEN pedal back to the horizontal (neutral) position to disengage the brakes.

ALWAYS APPLY THE BRAKES WHEN THE STRETCHER IS PARKED.

# Dropsides

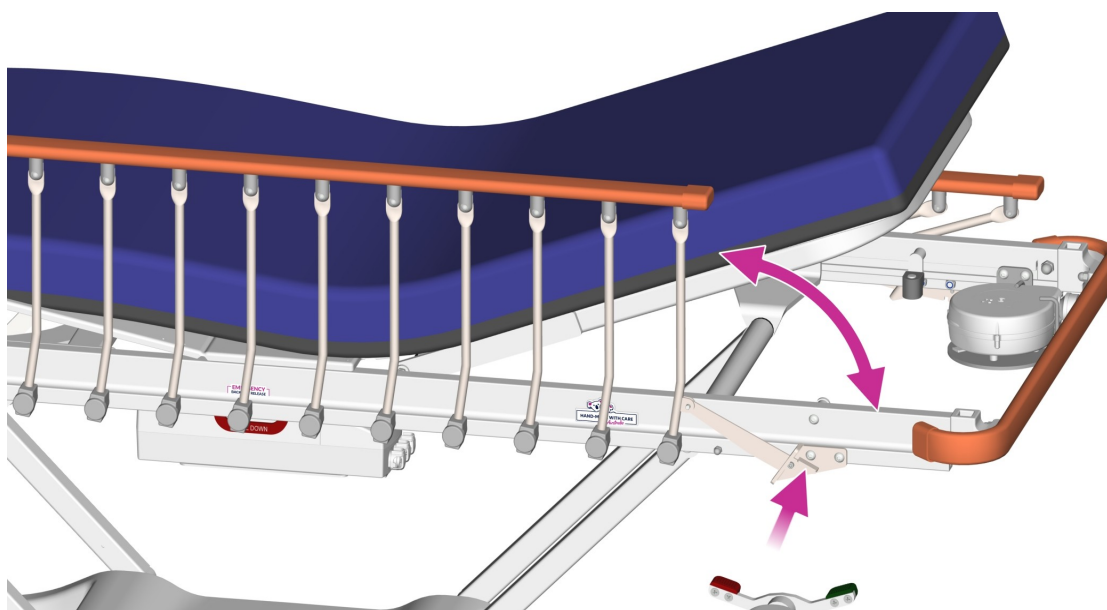

## To operate the dropsides

- There are varying styles of dropside, the most common being 5 vertical risers and custom options of 7 or 16 risers.
- To release, lift the dropside lock tab and then lower the dropside. Ensure the dropside is supported to control speed of lowering.
- Always check that all fingers, hands and limbs are clear before lowering dropsides.
- When the dropside is lifted into its upright position, it will automatically lock.

ALWAYS ENSURE THE DROPSIDE IS SECURELY LOCKED.



# Power Assisted Electric Operation

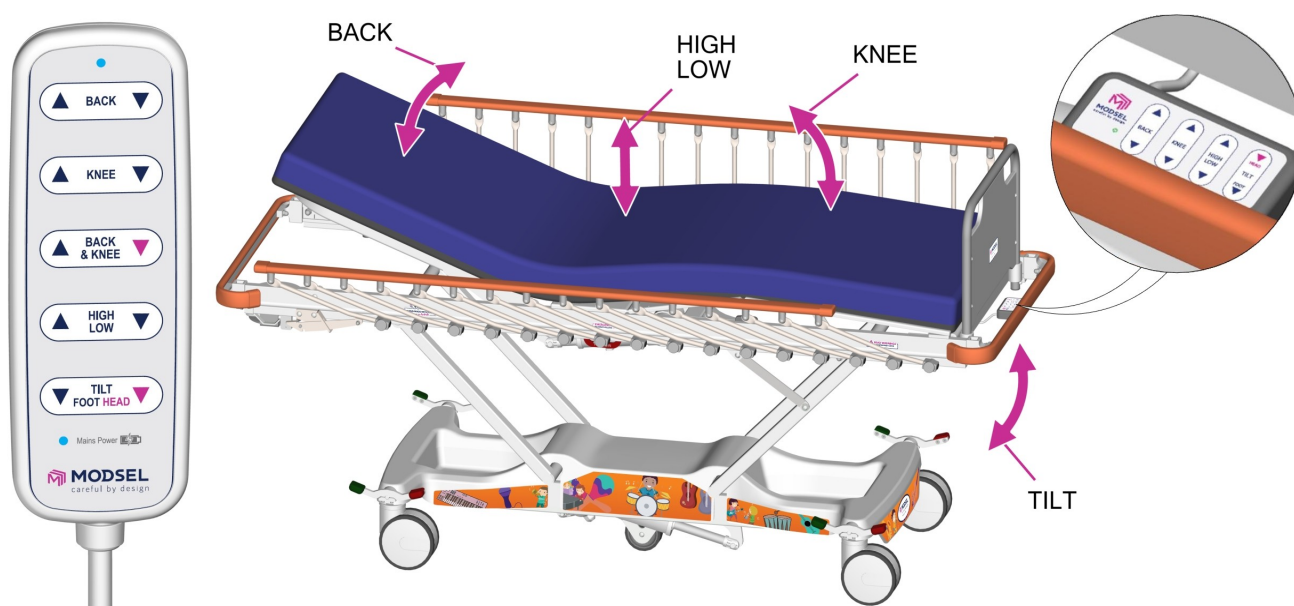

## To operate the backrest

- Press the UPWARD facing arrow labeled 'BACK' on the handset or end control to raise.
- Press the DOWNWARD facing arrow to lower.
- Always check that all fingers, hands and limbs are clear before lowering backrest.

## To raise and lower the stretcher top

- Press the UPWARD facing arrow labeled 'HIGH LOW' on the handset or end control to raise.
- Press the DOWNWARD facing arrow to lower.

## To tilt the stretcher top

- Press the DOWNWARD facing arrows labeled 'TILT (FOOT HEAD)' on the handset or end control to lower either end of the stretcher top.

## To raise and lower knee break

- Press the UPWARD facing arrow labeled 'KNEE' on the handset or end control to raise. Press the DOWNWARD facing arrow to lower.

## To contour the stretcher top

- Press the UPWARD facing arrow labeled 'BACK & KNEE' on the handset to raise both the backrest and knee break to a sitting position together.
- Press the DOWNWARD facing arrow to lower back to a the lying position together.

ALWAYS CHECK THAT THERE ARE NO OBSTRUCTIONS ABOVE OR BELOW THE TOP BEFORE ADJUSTING THE HEIGHT.

# Emergency Backrest Release (CPR)

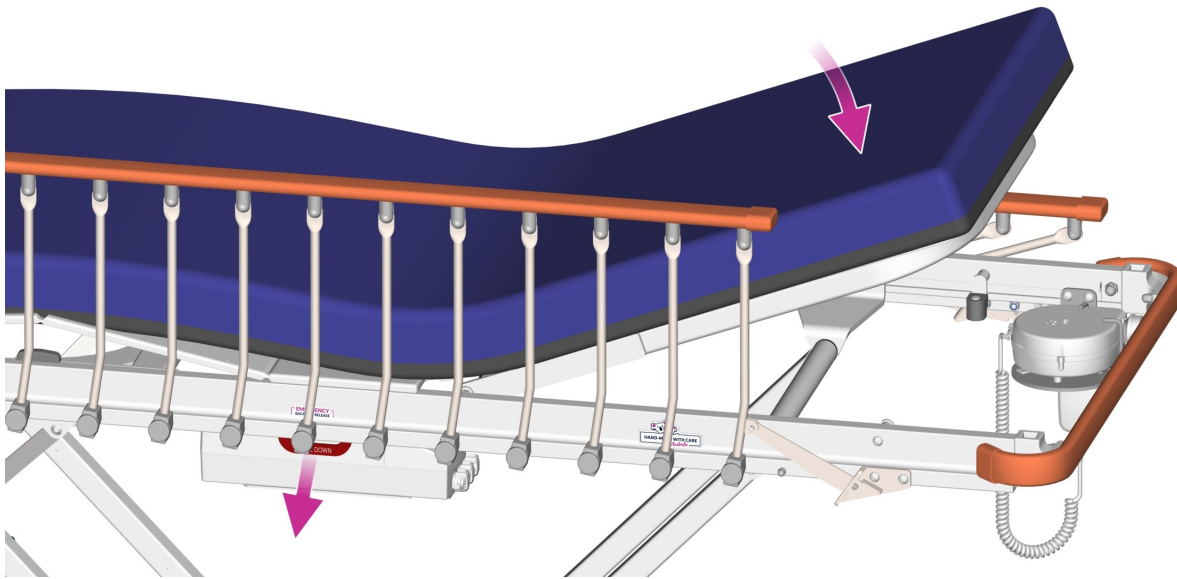

## To lower the backrest

- Pull the red handle on either side of the stretcher down to release.
- Ensure that the backrest is supported by a staff member each side before using the quick release.
- Always check that all fingers, hands and limbs are clear before lowering backrest.
- If the backrest quick release is activated, lower the backrest completely flat to reset.

ONLY USE THE BACKREST CPR QUICK RELEASE IN AN EMERGENCY - CONTINUOUS USE WILL PREMATURELY WEAR THE RELEASE MECHANISM.

# Battery Care

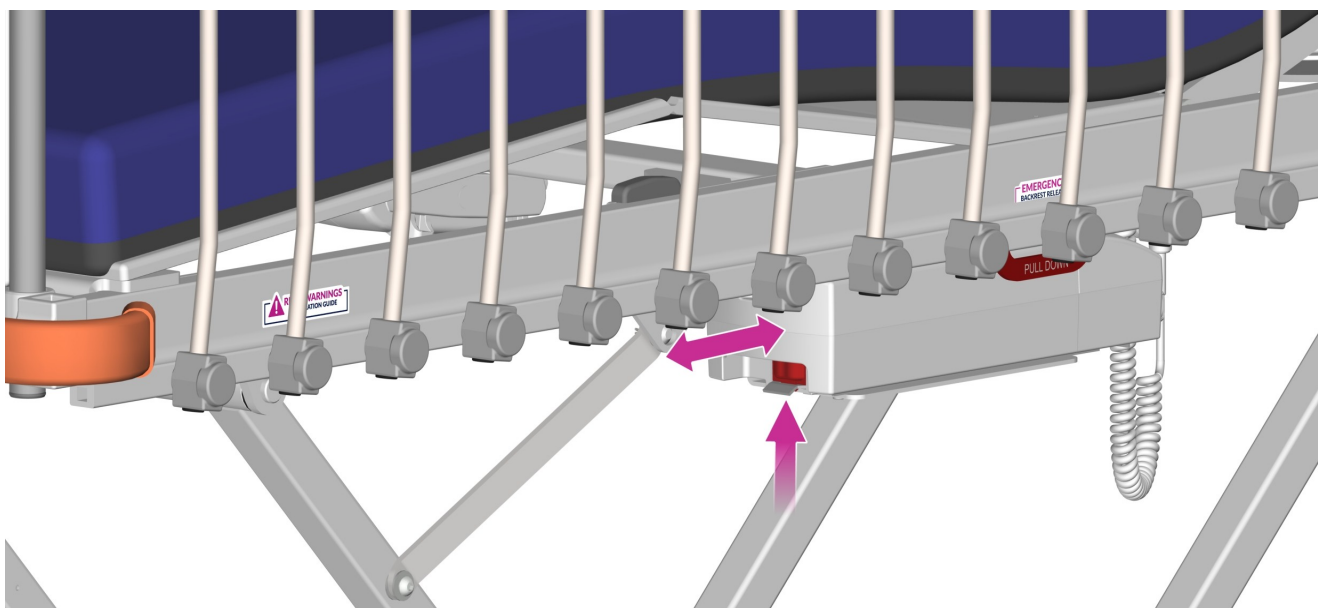

## To remove / install the battery

- To remove the battery, squeeze the lever under the end of the battery to release the lock and then pull away from the control box interface connection, allowing the battery to continue resting on its slide support. CAREFULLY LIFT THE BATTERY OUT.
- To install the battery, lift the battery into position and rest on its slide support. Push the battery firmly into the control box interface until you hear the lock click.

## Battery life

- The number of operations per charge will vary according to the frequency of use and stretcher loads.
- Do not continually run the battery to low charge as this will gradually reduce the battery life.
- Regular charging of the battery is recommended.
- On hearing an audible low battery warning tone from the unit during use, remove the battery for charging immediately.

## To charge the battery

- When the stretcher main power cable is connected to a standard 240V outlet the battery is automatically charging.
- Alternatively if there is a separate charging unit (option), it can be wall mounted and must be connected to a standard 240V power point.
- Action of removal and replacement of the battery on both the charger and the stretcher is similar, except that the wall charger may be mounted vertically.
- Charging time may take up to 6 hours and the battery may be left on charger permanently.

FAILURE TO COMPLY WITH THESE INSTRUCTIONS WILL RESULT IN SHORTENING THE BATTERY LIFE.

# Main Power Cable

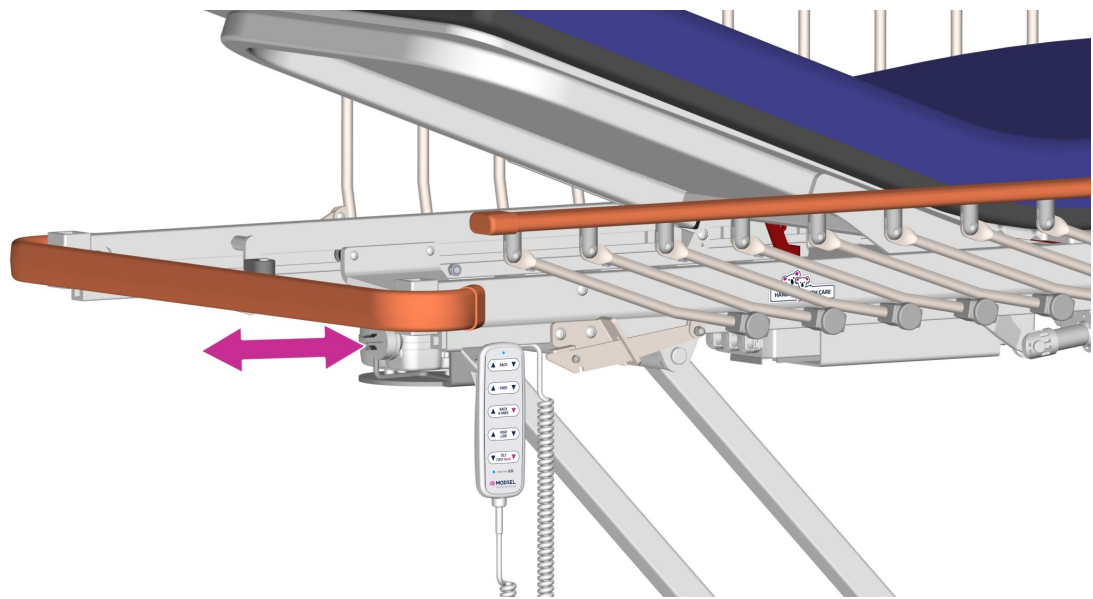

## To use the power cable

- It is recommended that the stretcher should be operated while powered via a standard 240V outlet.
- There is a battery backup to allow stretcher operation whilst unplugged.

ALWAYS ENSURE THE POWER LEAD IS UNPLUGGED AND STOWED CORRECTLY BEFORE MOVING THE STRETCHER.

# Accessory Sockets

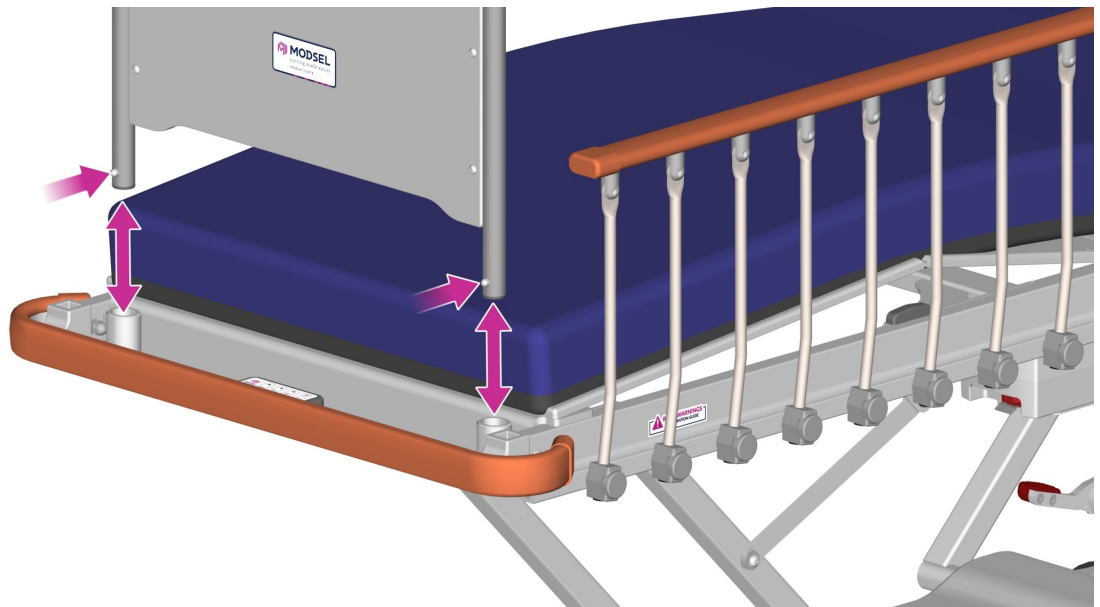

A pair of sockets are provided on the foot end of the stretcher top for a range of accessories such as end rails, monitor boards and folding foot boards. There is a 'head end' accessory socket option also available.

## Installing an accessory

- Loosely insert the accessory into both sockets and then either one at a time or with both hands upside down and using your forefingers, depress the lock buttons and allow the accessory to drop in.
- Ensure both locks have activated after installation.

## Removing an accessory

- Either one at a time or with both hands upside down and using your forefingers, depress the lock buttons and lift the accessory out slightly.
- Once both lock buttons are released, lift and remove the accessory completely.

# Cleaning

## **SURFACE CLEANING RECOMMENDED FOR ROUTINE CIRCUMSTANCES.**

- Do not hose, soak or submerge this stretcher. Surface clean only.
- Disinfect using your institution approved procedure; ensuring the surfaces are decontaminated, free from residues and dry before use.
- Clean with alcohol based sanitisers or with appropriate water-based residues removal, or consider quaternary ammonium compounds\*
- Machine washing and autoclaving is not recommended.

\* Institution approved brands at manufacturer's recommended concentrations.

## **TO CLEAN and DISINFECT**

- CONSULT your facility contamination control plan.
- Consult care instructions for the accessories including mattress that have been supplied separately.
- Spot clean any visible soiling.
- Wipe over all surfaces with a suitable disinfectant, ensuring a suitable contact time.
- Rinse or remove residues as merited.
- Store indoors in a clean and dry environment, protected from contamination.

## **DO NOT**

- Tumble dry, use phenolic disinfectants, abrasive or aqueous cleaners, steel wool or non-proprietary cleaners containing solvents.
- Permanently remove any fixtures or fittings integral to the safe operation and use of the stretcher.
- Allow fluid to contact electrical fittings, fixtures or connectors.

If you suspect significant contamination, consider fogging and/or UVC exposure in conjunction with advice from Modsel and your contamination control representative.

**DAMAGE CAUSED BY THESE PROCESSES ARE IDENTIFIABLE AND MAY VOID WARRANTY.**

# Mattress Care

## **SURFACE CLEANING RECOMMENDED FOR ROUTINE CIRCUMSTANCES.**

- Do not breach the fabric surface with sharps or other abrasive materials.
- Disinfect using your institution approved procedure; ensuring the surfaces are decontaminated, free from residues and dry before covering with a sheet.
- Clean with alcohol based sanitisers or consider quaternary ammonium compounds\* or Aldehydes\* or Peroxides\*
- Wipe with a clean cloth dampened with a mild detergent solution (or) approved sanitiser.
- Residues can be removed with clean water.
- DO NOT USE BRUSHES OR PHYSICALLY ABRASIVE CLEANERS - these will destroy the waterproof coating of the fabric.
- Do not scrub around the zipper.
- Do not dry clean.
- If you suspect contamination, remove cover, inspect and, if merited machine wash.

\* Selected brands at manufacturer's recommended concentrations.

## **TO MACHINE WASH.**

- Where laundering is required, wipe surface as clean as possible and sanitise using a suitable disinfectant.
- If a zipper is present, fully unzip the cover and remove mattress core TAKING CARE not to contaminate the foam core.
- Store the foam core flat in a clean, dry location, protected from contamination.
- Leave the zipper open as fabric is waterproof and interior will not be correctly laundered if zipper is closed.
- Hot water and most chemical sanitisers can be used.
- Rinse well. Do not wring. Dry flat where possible.
- Dry naturally at room temperature away from direct heat.
- DO NOT IRON.
- When completely dry, refit to foam core. Close the zipper completely.
- Store flat, clean and dry when not in use and protect from contamination.

## **ALWAYS DISCARD THE MATTRESS IF THE;**

- Fabric cover is breached, worn or broken or,
- The zipper does not fully close or,
- The core is wet or malodorous or,
- The mattress/cover no longer appears hygienic after the prescribed cleaning procedure.
- Disinfect before disposal.
- DO NOT re-purpose or recondition this device.

# Troubleshooting

## **The brakes don't work**

- Do the brake castors have firm contact with the floor.
- Is there sufficient grip and not on a slippery surface.
- Check that the brake pedals lock fully into the brake position.
- Check there is no damage or wear requiring adjustment to the braking castor system.
- If not working, REPORT TO MANAGEMENT.

## **The dropside won't lock properly**

- Lift the dropside to its upright position.
- Pull backwards on the dropside (against the locking catch) and check it has locked correctly.
- Check there is no visible damage to the dropside catch or arm.
- If not working, REPORT TO MANAGEMENT.

## **The backrest is clicking or the quick release (CPR) doesn't work**

- Check there is no visible damage to the release knobs or the cables.
- Pull one of the release knobs outwards firmly and then lower the backrest completely flat to reset the quick release system.
- Raise the backrest a little way via the electronic handset and check if the quick release is engaged (locked in correctly) by applying some downwards force on the backrest.
- If not working, REPORT TO MANAGEMENT.

## **The electric system won't work**

- Ensure the battery is on the unit and fully charged.
- If plugged into main power, ensure the power point is turned on.
- Check there is no visible damage to the handset or its cable.
- If still not working, REPORT TO MANAGEMENT.



# Maintenance

Problems that could be encountered with mobile stretchers involve siderails not locking, wheel locks and/or brakes not functioning or engaging correctly, or frame/structural components failing. Loss of functionality could cause the platform surface to tilt, spilling the patient onto the floor. Routine inspection of castors, siderails, and other frame components can usually prevent these problems.

After each (12) twelve months of use, the stretcher must be checked in accordance with our recommended Service Checklist.

[An approved \*\*MODSEL Service Checklist\*\* can be downloaded online from this link](#)

**TO ENSURE WARRANTY, PERIODIC MAINTENANCE RECORDS MUST BE RETAINED.**

## **Malfunction**

- Any failure of the stretcher to operate correctly should be immediately investigated.
- Isolate and quarantine the stretcher with the suspected malfunction.
- Contact Modsel or authorised agent for advice.

## **Disposal**

- Contact Modsel or your institution expert for advice on disposal of this device.
- DO NOT repurpose this device. Modsel as the legal manufacturer of this medical device can advise if it can be reconditioned.

# 15 Year Warranty

## **We warrant in the event that:**

- Any fabricated structure failure is found within (15) fifteen years from the date of invoice due to faulty workmanship.
- A part or parts of plastic not covered by the above warranty, are found within (5) five years from the date of invoice to have a structural defect.
- All electric parts not covered by the above warranty are found to have a manufacturing defect within (2) two years from the date of invoice.
- The stretcher mattress not covered by the above warranty, is found within (2) two years from the date of invoice to have defect. This includes faulty cover material, faulty seam welding and foam failure.
- Any externally supplied moving parts including springs, castors, hydraulic rams, gas struts, pivots etc not covered by the above warranty, are subject to third party warranties or found within (1) one year from the date of invoice to have a structural defect.
- Removable/ rechargeable batteries not covered by the above warranty are found to have a manufacturing defect within (3) three months from the date of invoice.
- The purchaser, within (14) fourteen days of discovery of the defect or defects gives written notice to Modsel or their distributor or agent, and:

## **The defect or defects are not due to:**

- Cosmetic issues such as fading, crazing, discoloration.
- Lack of maintenance as per minimum requirements.
- Vandalism, negligence, abuse, accidents, improper installation or normal wear and tear.
- Products tampered with or altered, modified or repaired by anyone when not approved by Modsel.
- Conditions such as close proximity to salt, extreme hot or cold temperatures.
- Non-adherence to cleaning and care instructions.
- Permeation of fluid substances into foam.
- Incorrect usage of electric parts as per the operating directions.

## **Modsel will:**

At our option, repair or replace the part or parts found within our reasonable judgement to have been defective in workmanship or materials. Should your stretcher ever require attention due to a failure as defined under the warranty above, please contact Modsel or your local distributor from whom your stretcher was originally purchased.

# Manufacturing Records

Manufactured by **Modsel** Pty Ltd,

54 - 56 Industrial Ave, Maryborough, QLD, 4650, Australia.

Contact +61 1300 785 790

Class I Medical Device ARTG Included

Product Model/Serial Number;

Mattress Model/Batch Number;

Date of Manufacture;



**MODSEL**

[modsel.com](https://modsel.com) ▶